

Cursive Handwriting

Lowercase Letters - H.W.T.

NAME: _____



c i s c

Name: _____

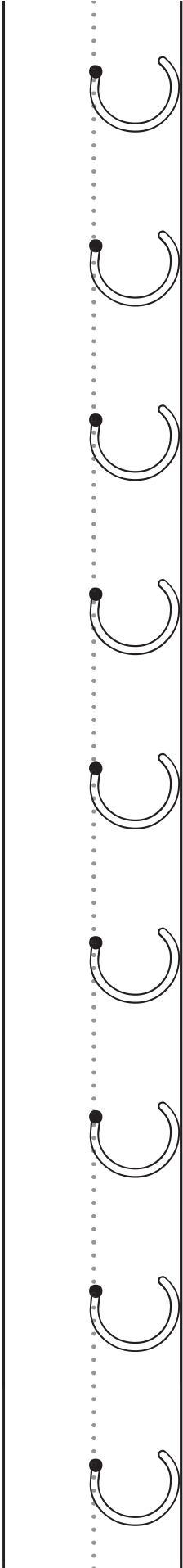
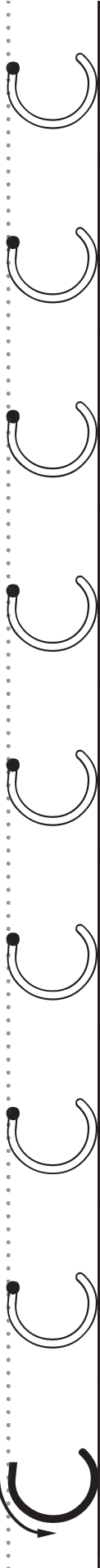
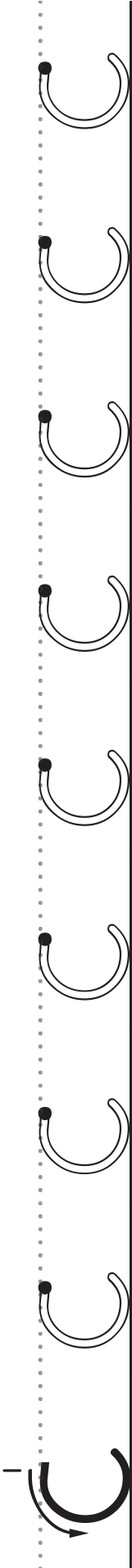

teacher check:

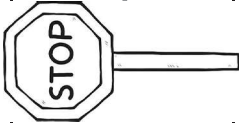

cursive c:

a i s a

Name: _____

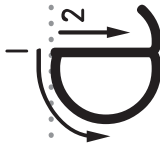

A A A A A A A A

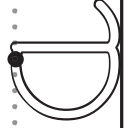
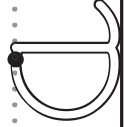
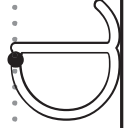
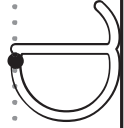
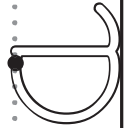
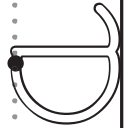
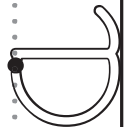

teacher check:

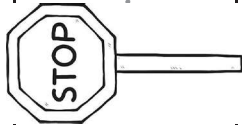

cursive a:

d i s d

Name: _____

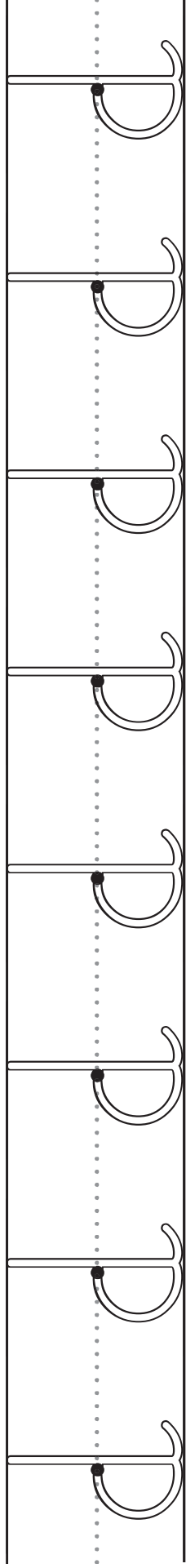
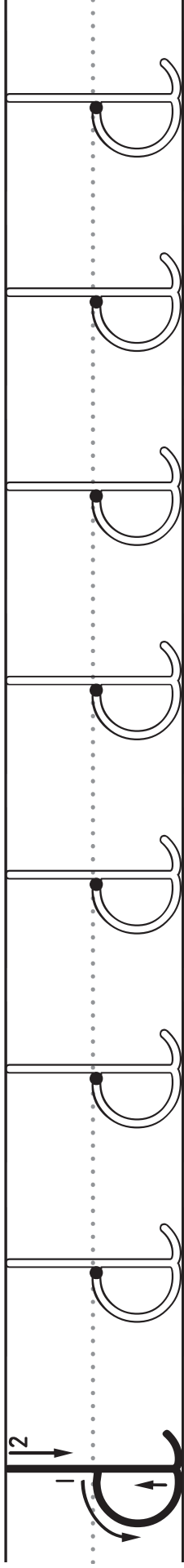

teacher check:

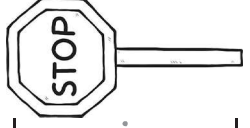

cursive d:

g i s g

Name: _____

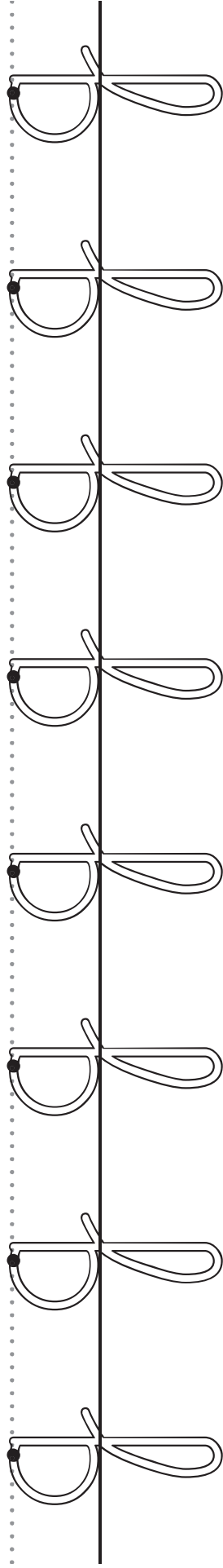
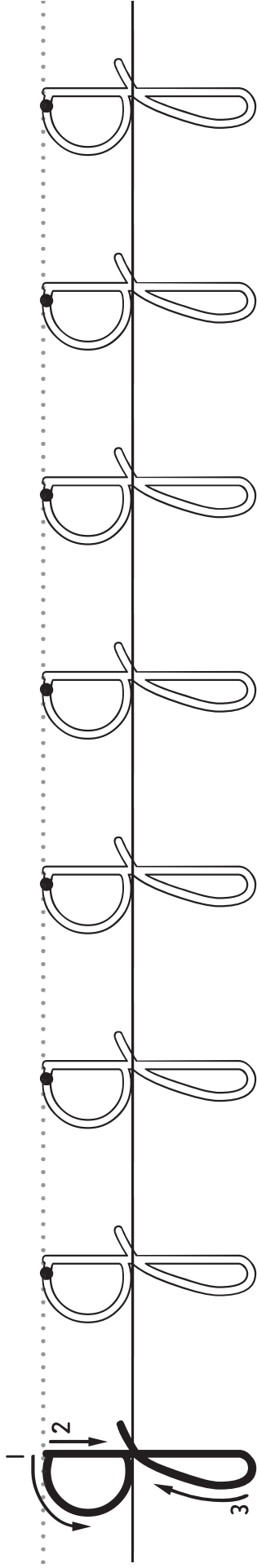

teacher check: _____

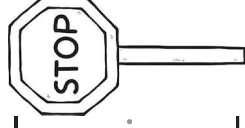

.....

.....

.....

cursive g:

h i s h

Name: _____

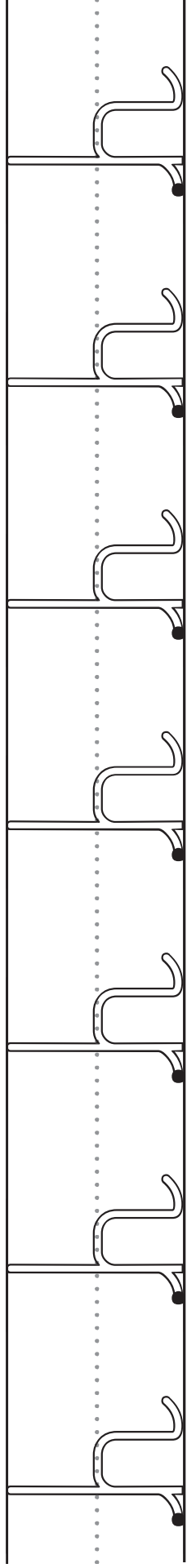
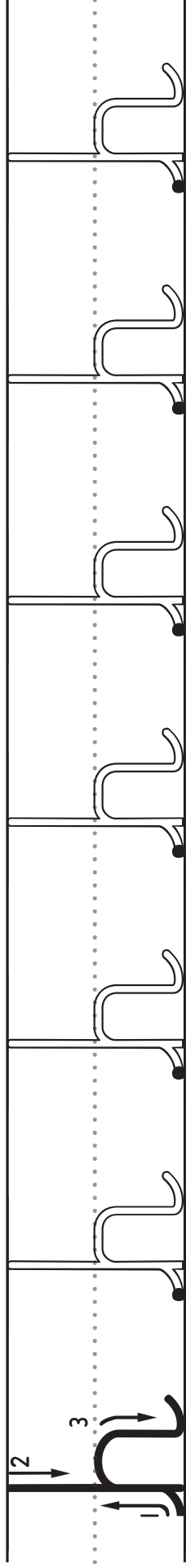

teacher check:

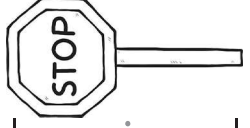

cursive h:

t i s t

Name: _____

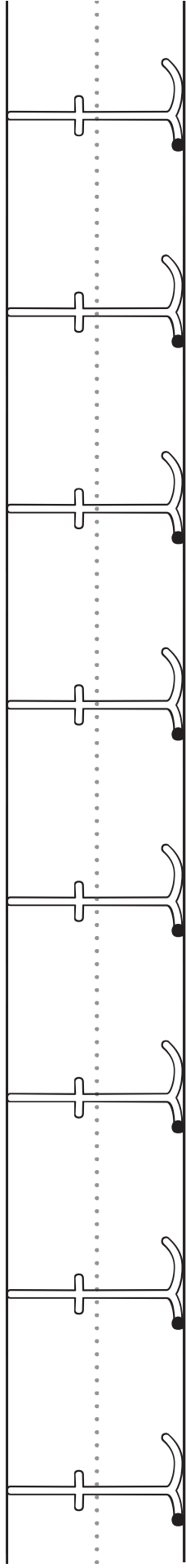
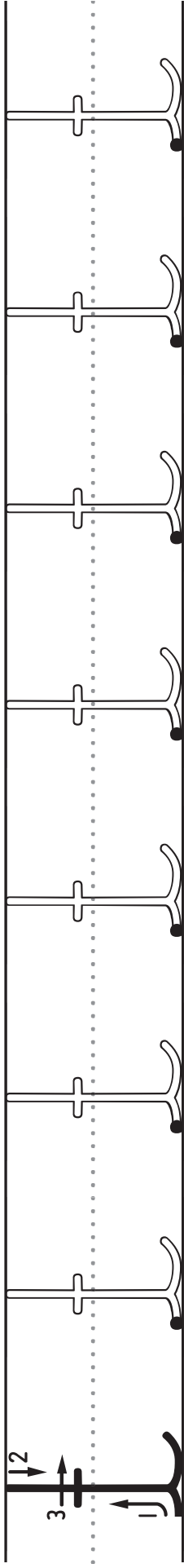

teacher check:

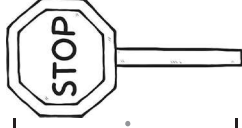

cursive t:

p i s p

Name: _____

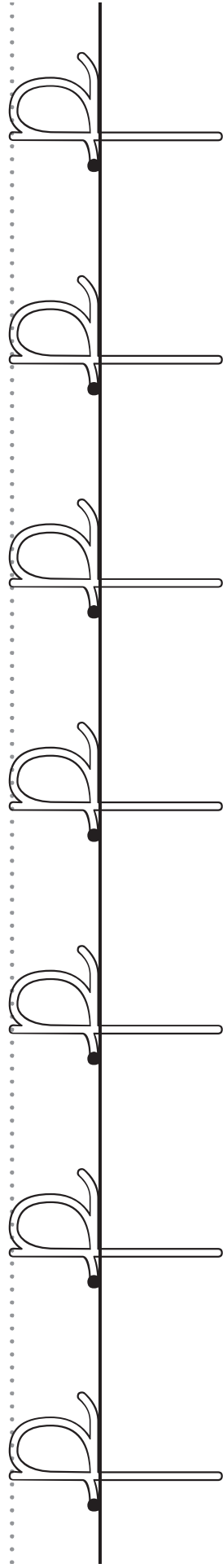
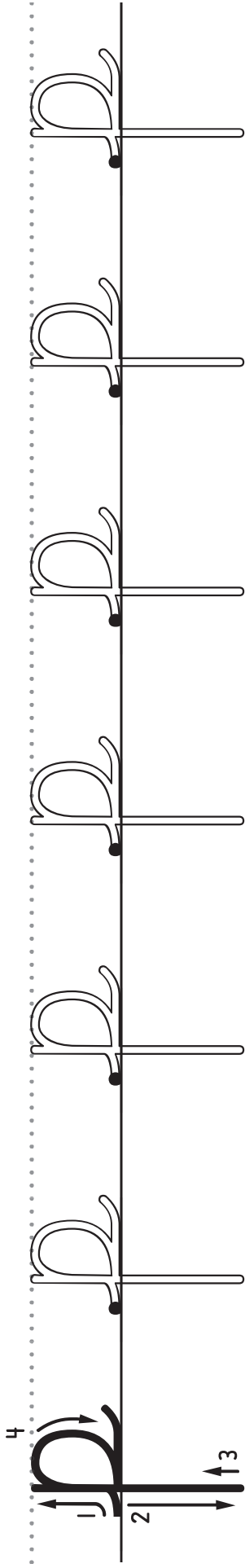

teacher check: _____

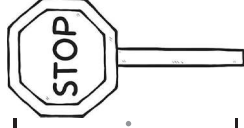

e i s l

Name: _____

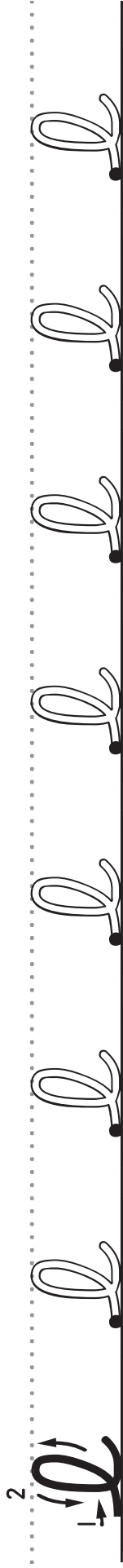

teacher check:

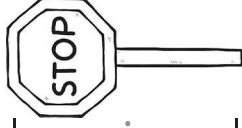

cursive e:

l i s l

Name: _____

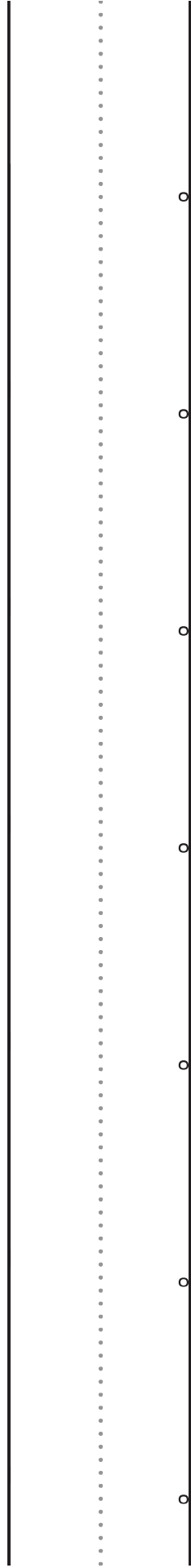
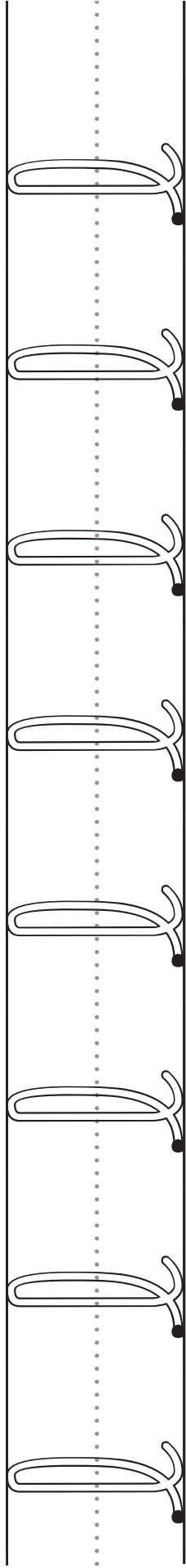
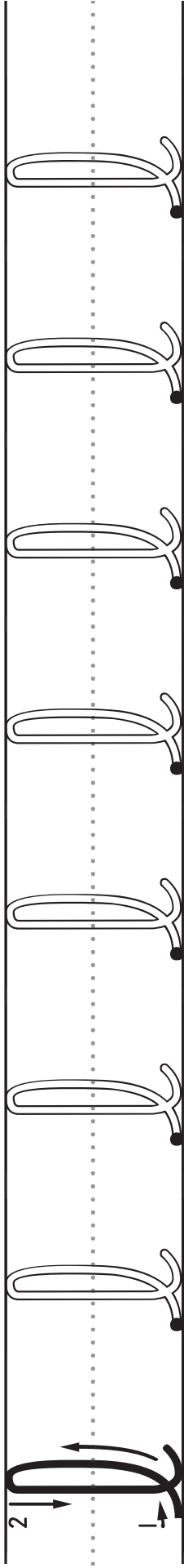

teacher check:

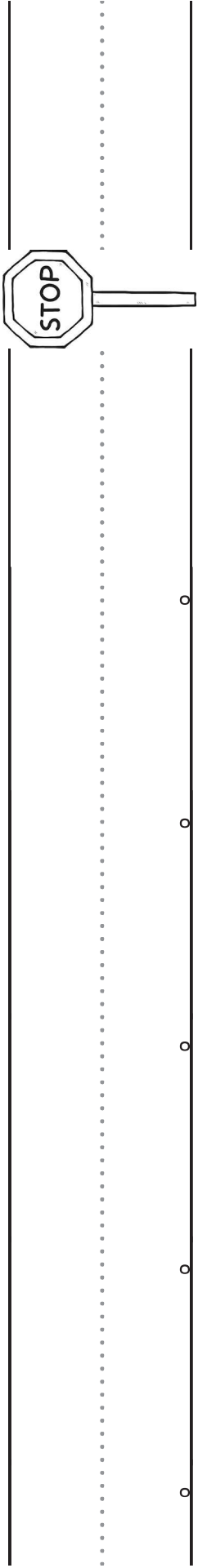
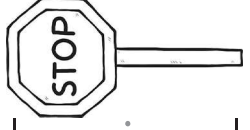

cursive l:

f i s f

Name: _____

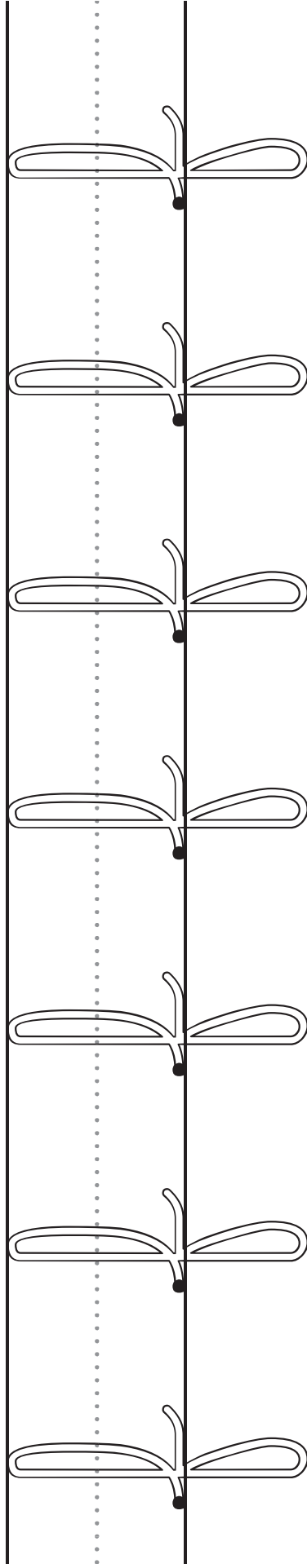
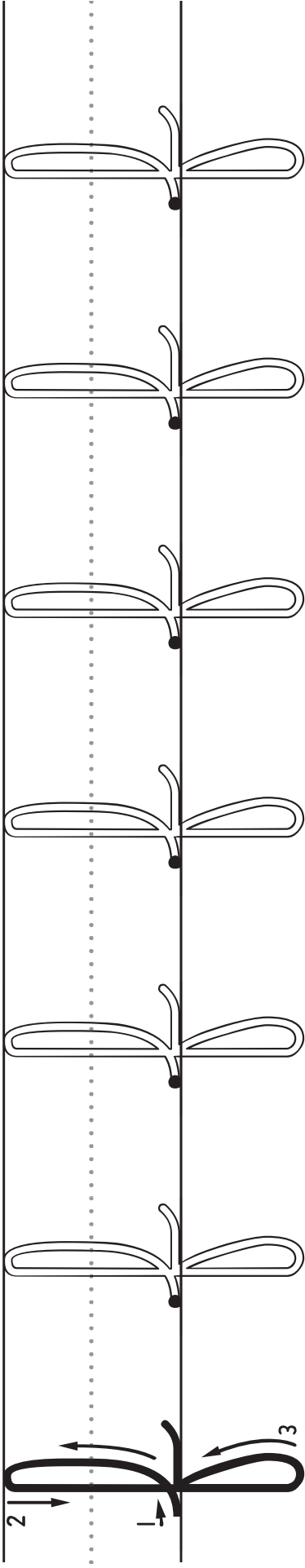

teacher check: _____

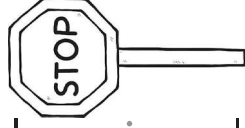

cursive f:

u i s u

Name: _____

u u u u u u u u

u u u u u u u u

u u u u u u u u

teacher check:

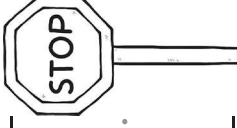

u u u u u u u u

cursive u:

y is y

Name: _____

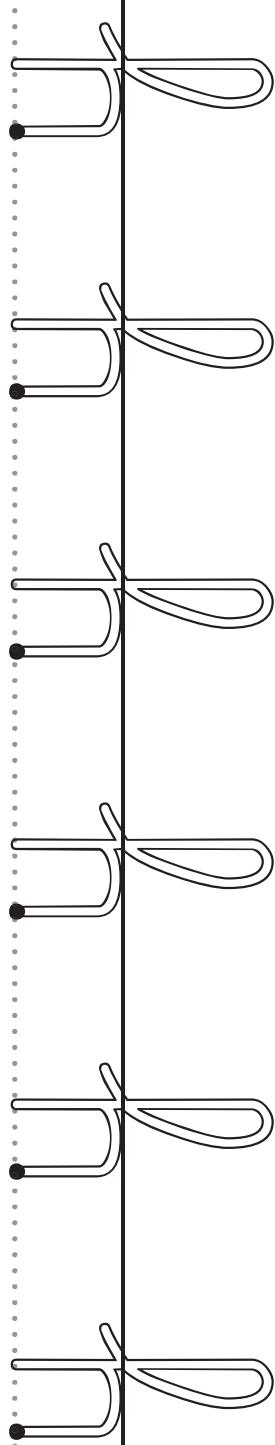
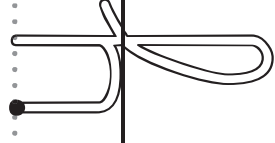
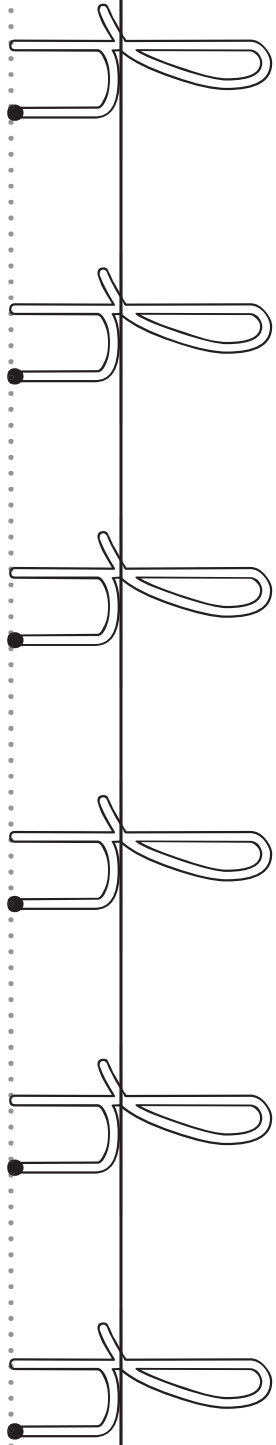

teacher check: _____

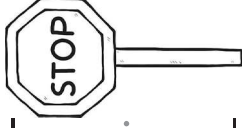

..... y y y y y

cursive y:

i i s i

Name: _____

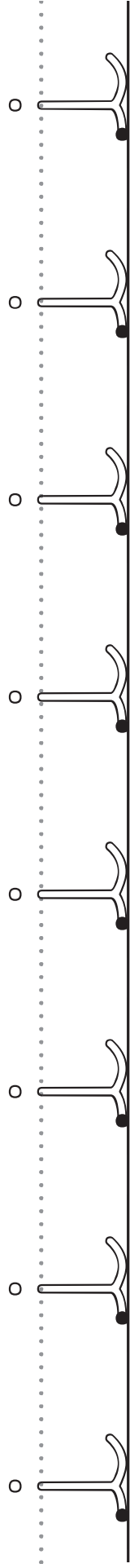
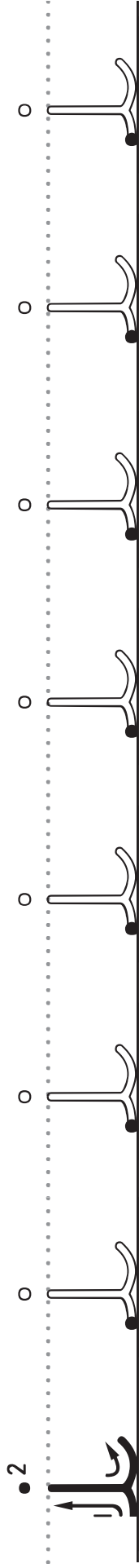

teacher check:

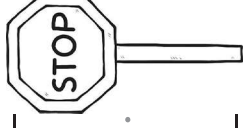

cursive i:

j i s j

Name: _____

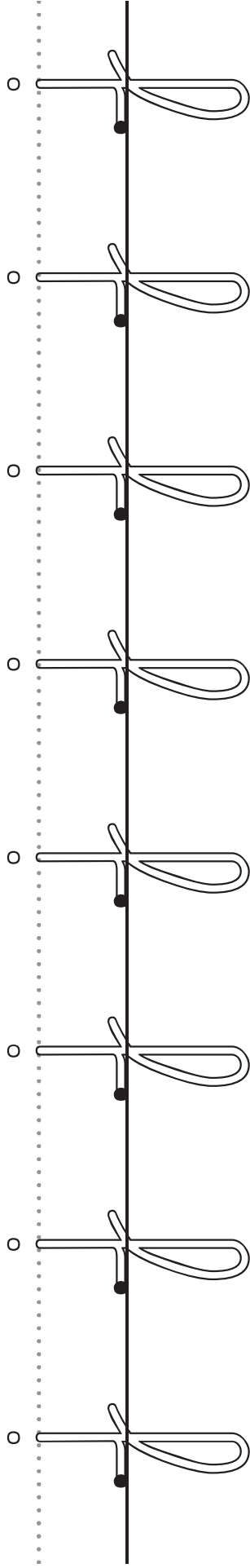
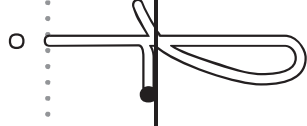
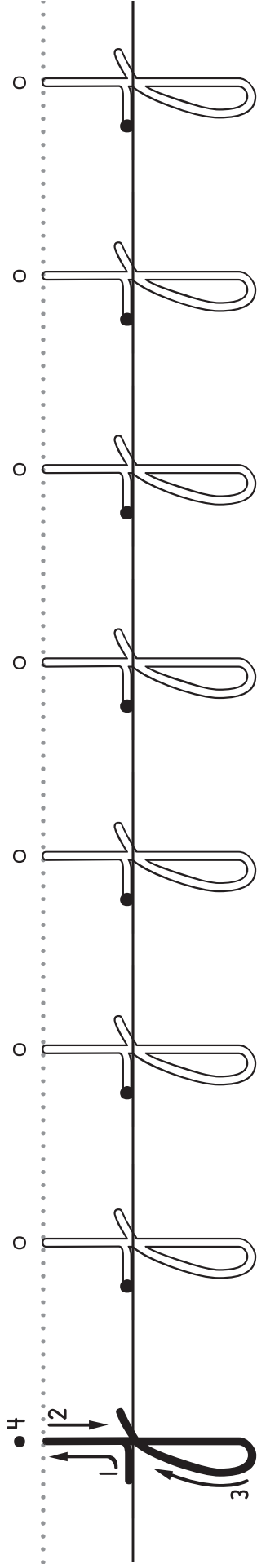

teacher check:

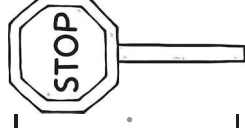

cursive j:

k i s k

Name: _____

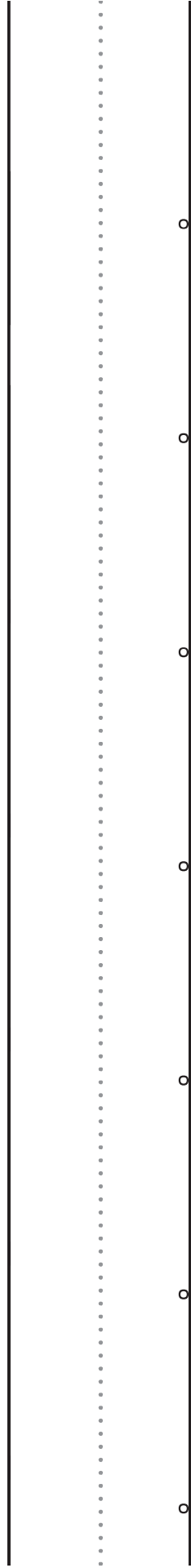
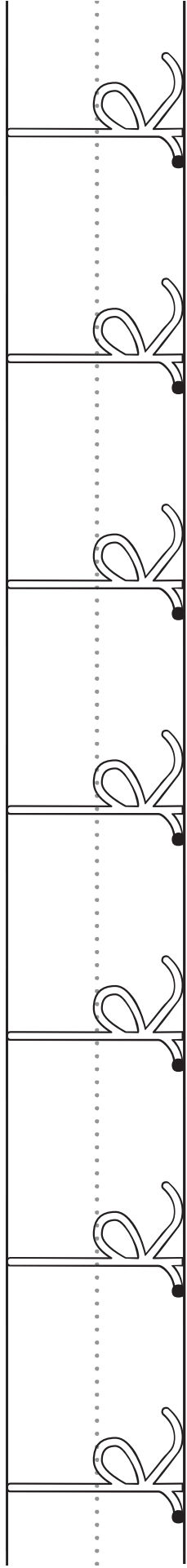
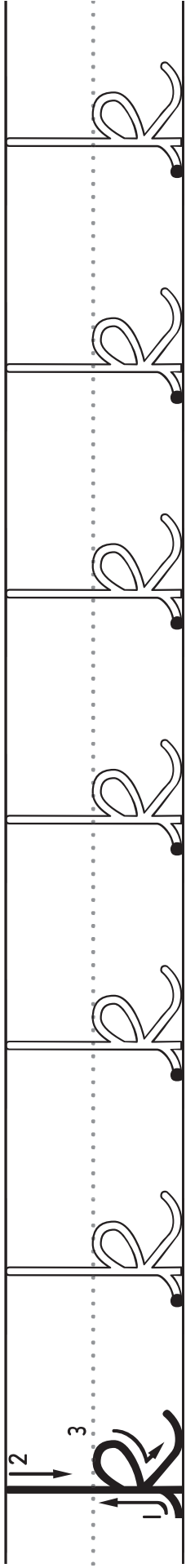

teacher check:

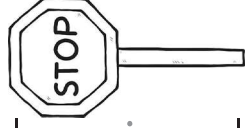

cursive k:

r i s r

Name: _____

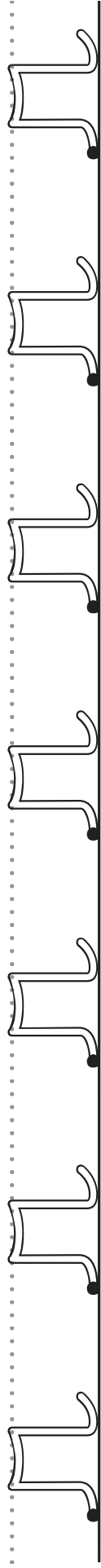
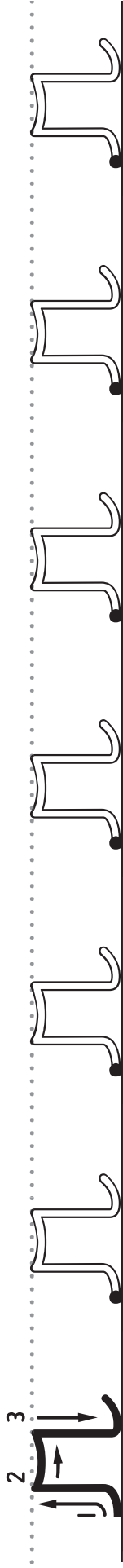

teacher check: _____

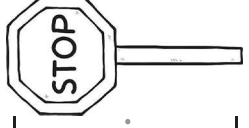

cursive r:

s i s A

Name: _____

Tracing row 1: A cursive letter 'A' with stroke order arrows and numbers 1 and 2, followed by five more cursive 'A's on a set of three horizontal lines.

Tracing row 2: Five cursive 'A's on a set of three horizontal lines.

Tracing row 3: A series of small circles on a set of three horizontal lines.

teacher check:

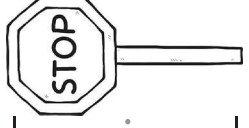

Tracing row 4: A series of small circles on a set of three horizontal lines.

cursive s:

o i s o

Name: _____

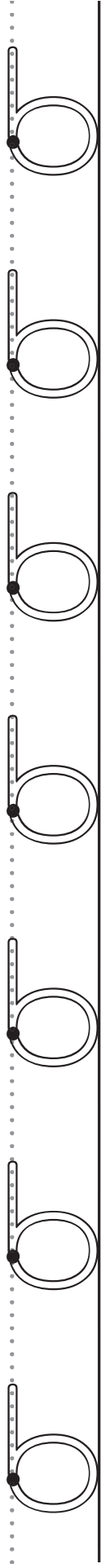
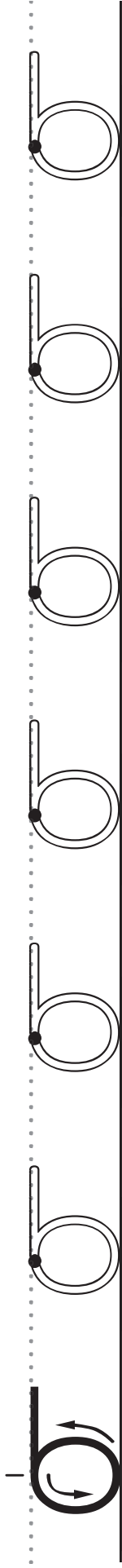

teacher check: _____

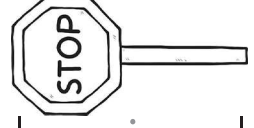

cursive o:

W i s w

Name: _____

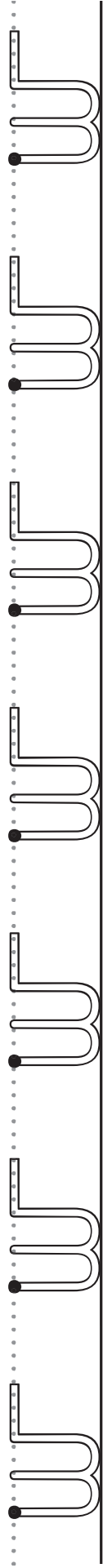
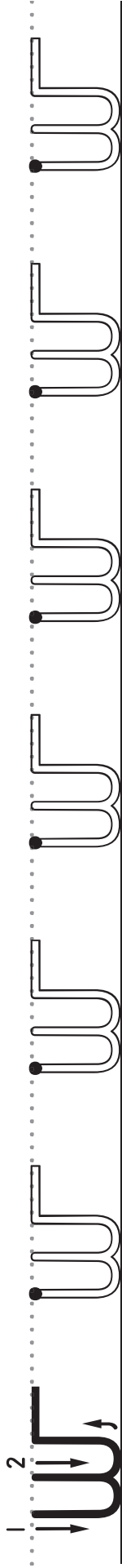

teacher check:

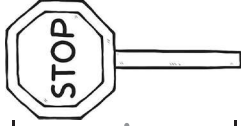

cursive w:

b is b

Name: _____

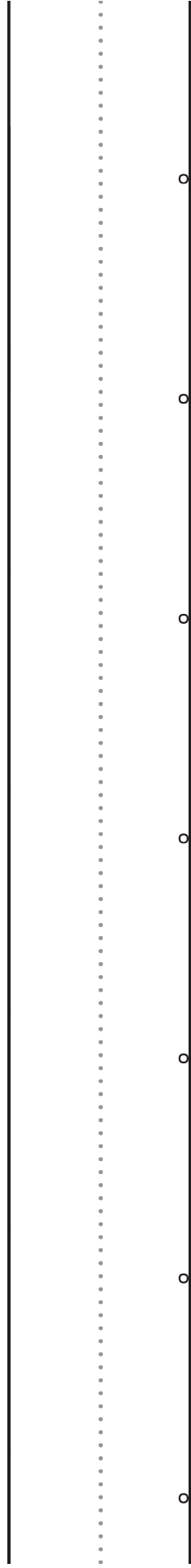
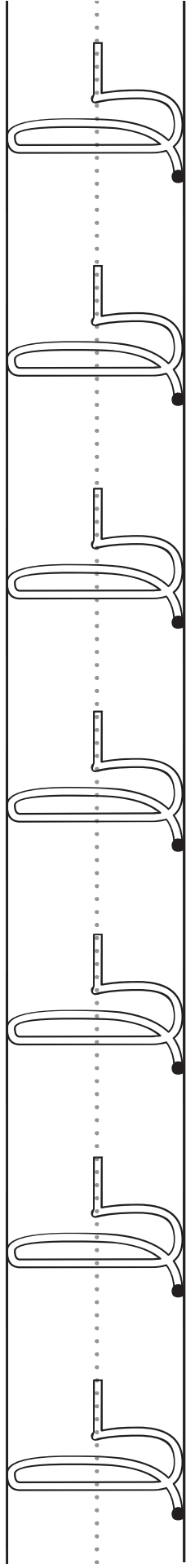
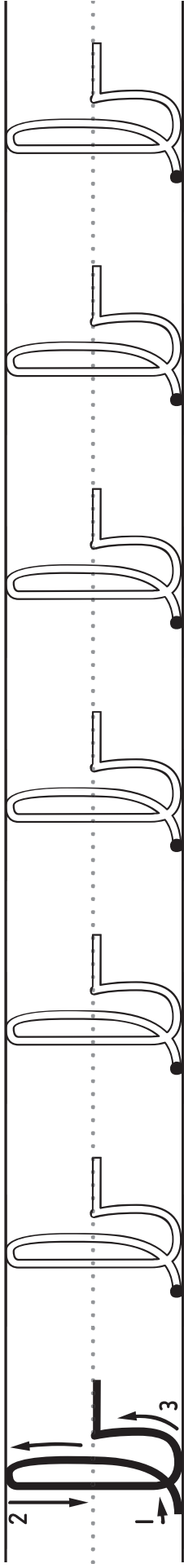

teacher check:

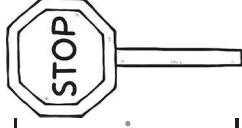

cursive b:

v i s v

Name: _____

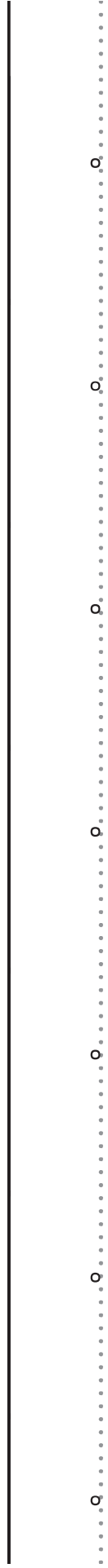
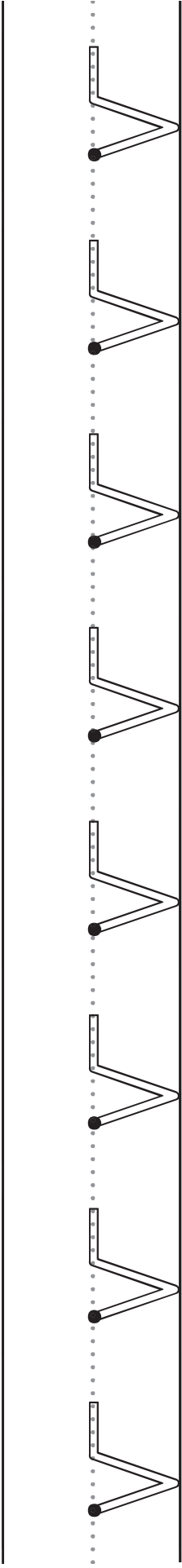
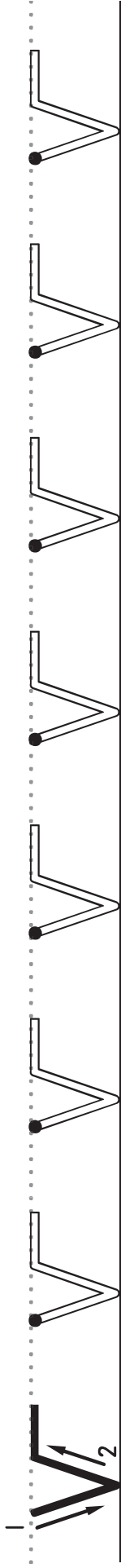

teacher check: _____

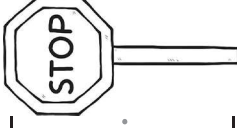

cursive v:

m i s m

Name: _____

¹ ² ³ m m m m

m m m m m

o o o o o o o

teacher check:

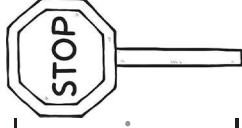

o o o o o

cursive m:

n i s m

Name: _____

¹ ² m m m m m

m m m m m

o o o o o o o o o o

teacher check:

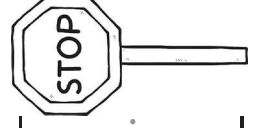

o o o o o o o o o o

cursive n:

x i s x

Name: _____

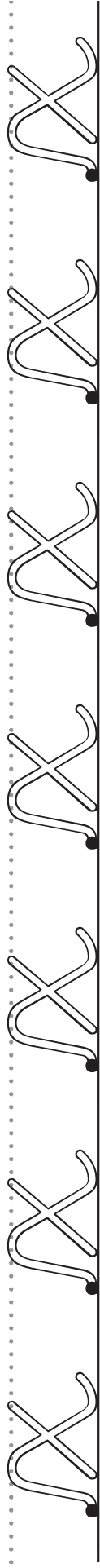
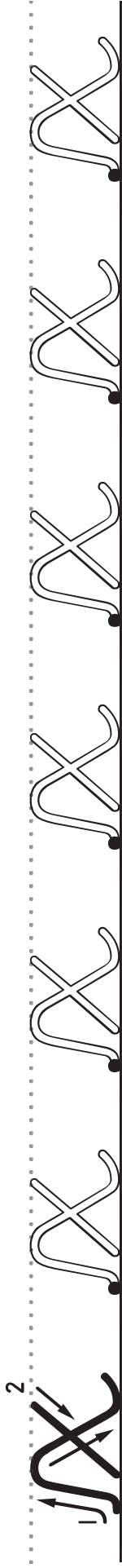

teacher check: _____

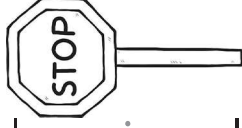

cursive x:

q is q

Name: _____

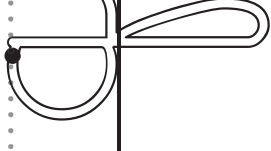
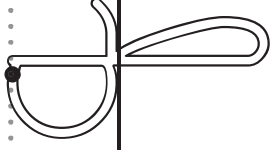
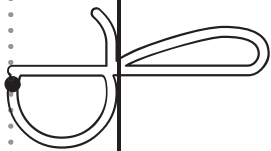
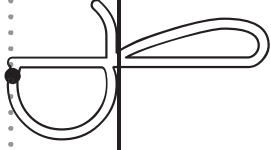
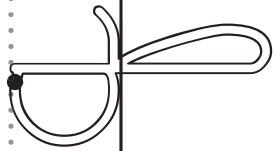
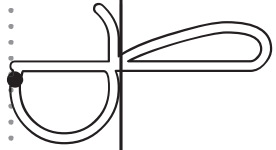
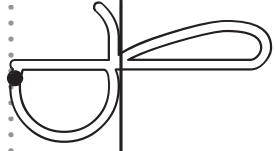
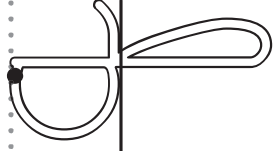
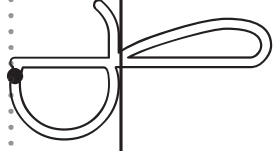

teacher check:

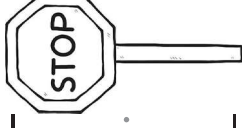

cursive q:

z is z

Name: _____

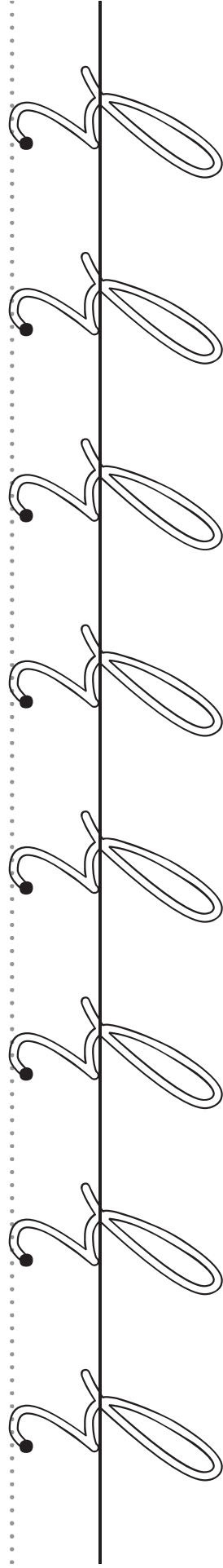
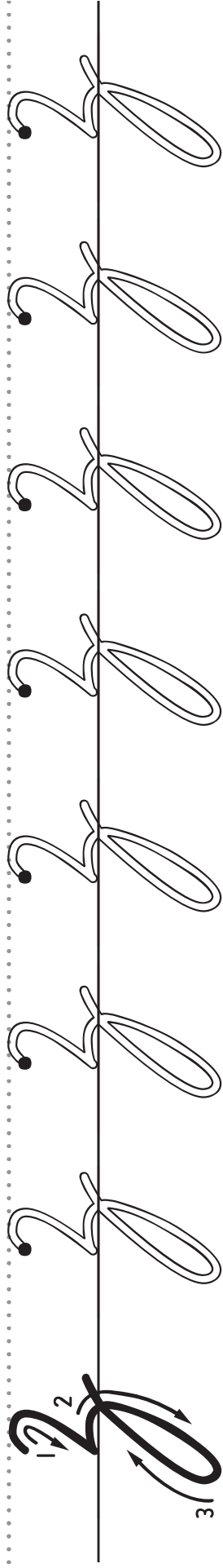

teacher check: _____

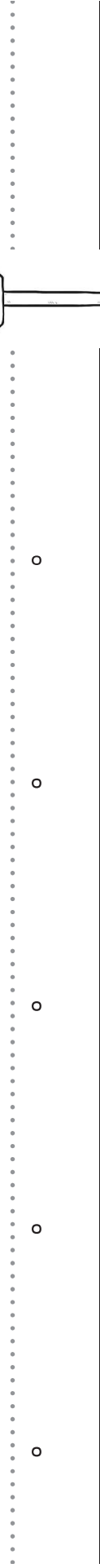
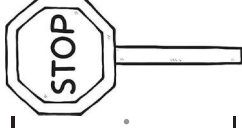

cursive z: