

# Cursive Handwriting

Lowercase Connections - H.W.T.

NAME: \_\_\_\_\_



c i s c

Name: \_\_\_\_\_

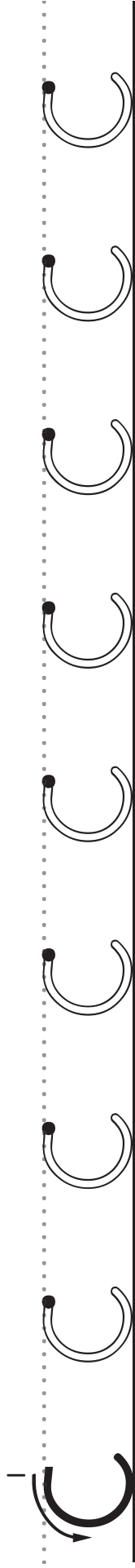

teacher check:

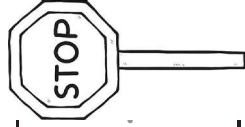

cursive c:

Start on the dot. Copy the models.



a i s a

Name: \_\_\_\_\_

a a a a a a a

teacher check:

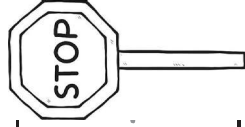

.....

cursive a:

Start on the dot. Copy the models.

a a a a a

a a a a a

dis d

Name: \_\_\_\_\_

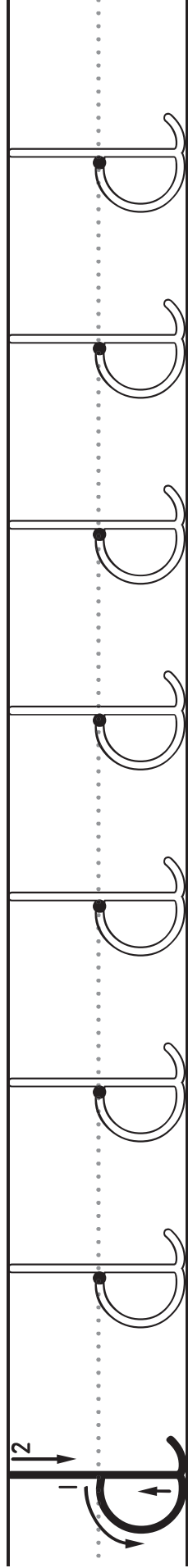

teacher check:

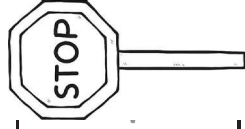

cursive d:

Start on the dot. Copy the models.

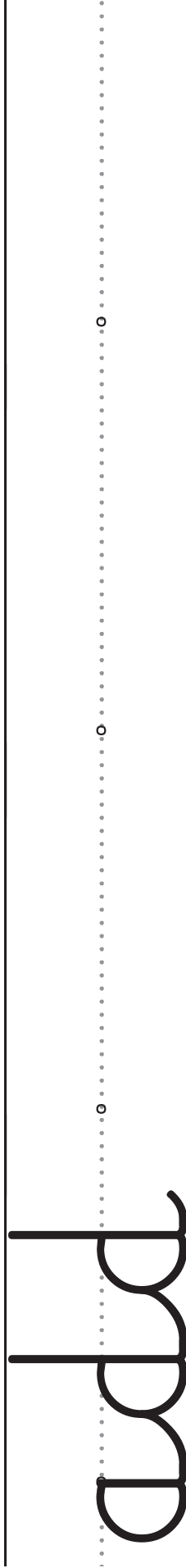
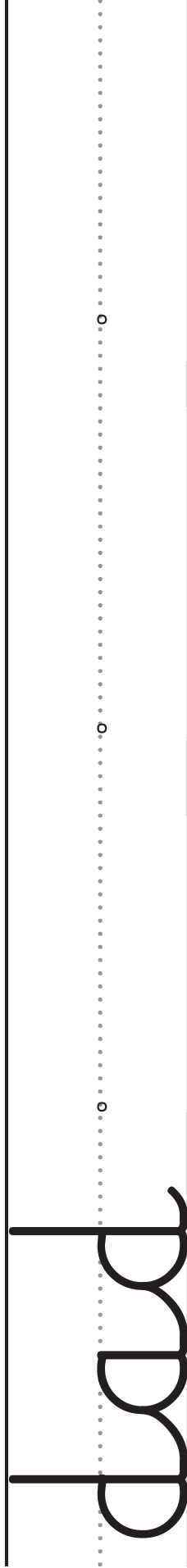

g i s g

Name: \_\_\_\_\_

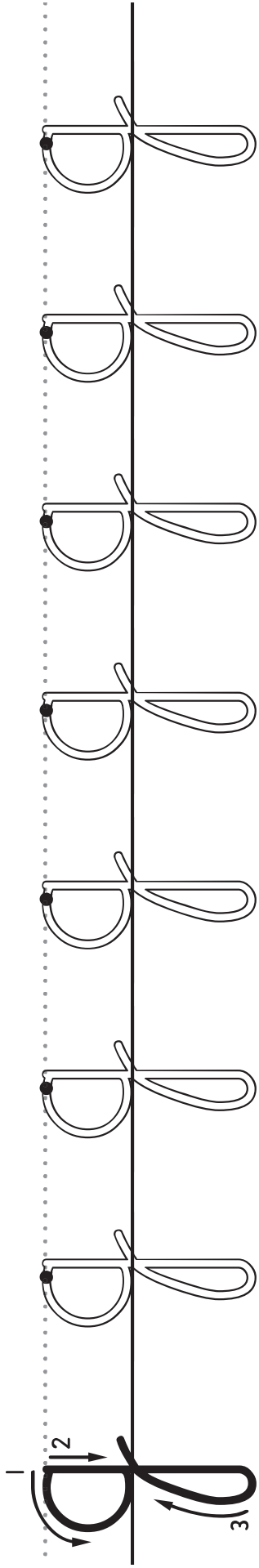

teacher check:

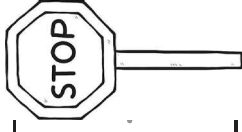

cursive g:

Start on the dot. Copy the model.

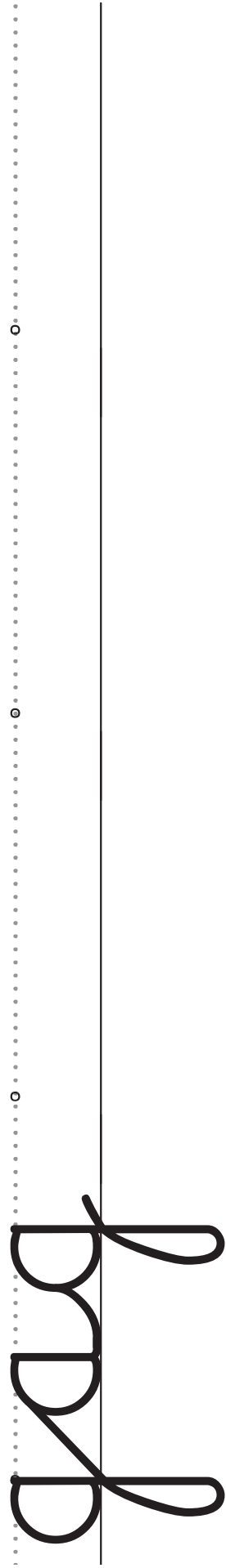

h i s h

Name: \_\_\_\_\_

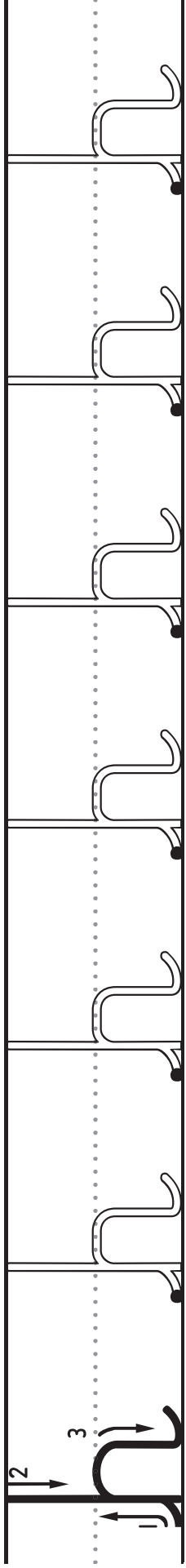

teacher check:

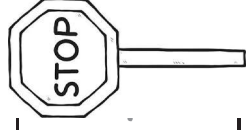

cursive h:

Start on the dot. Copy the models.

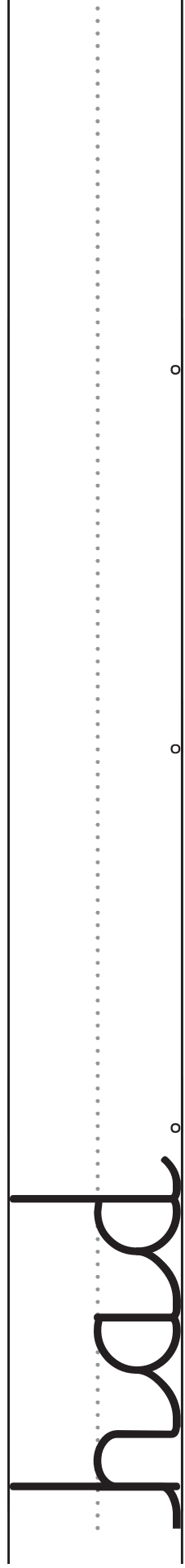
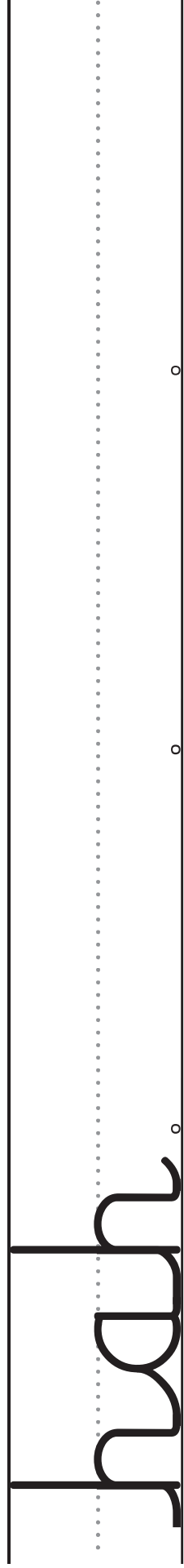

t i s t

Name: \_\_\_\_\_

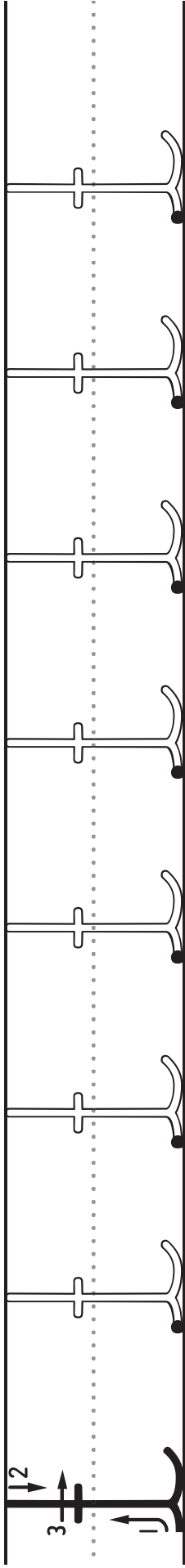

teacher check:

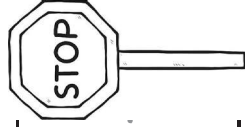

cursive t:

Start on the dot. Copy the models.

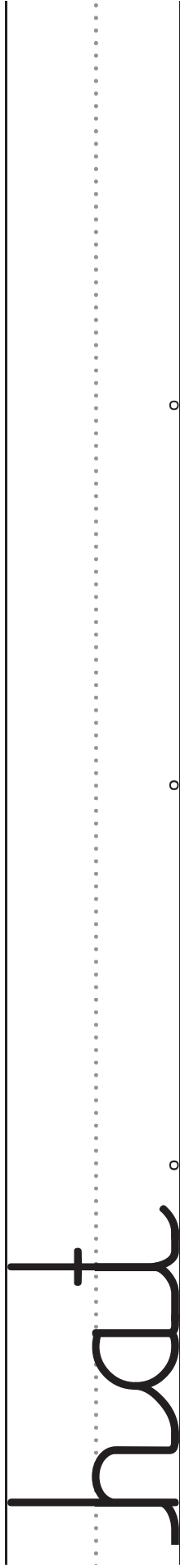
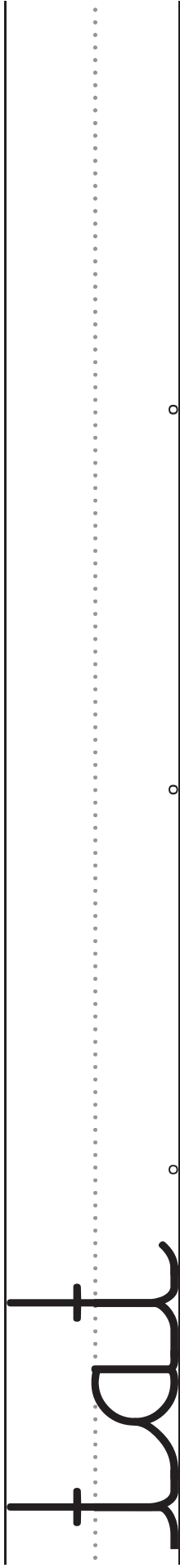

p i s p

Name: \_\_\_\_\_

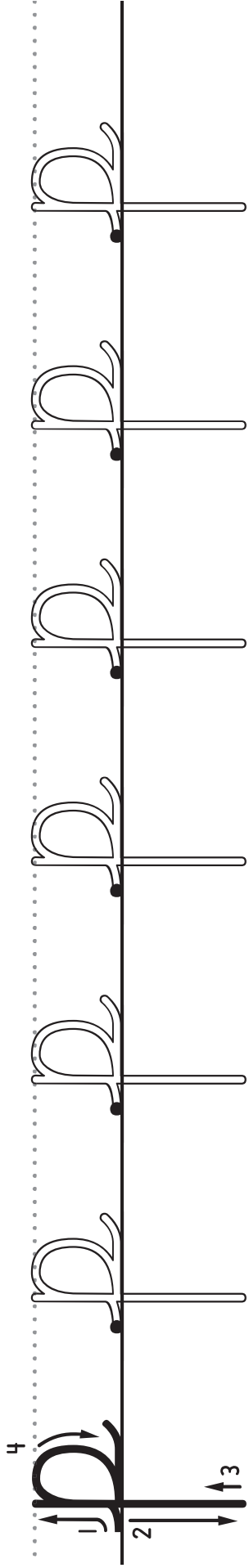

teacher check: \_\_\_\_\_

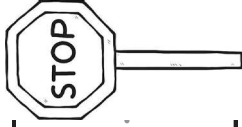

cursive p:

Start on the dot. Copy the model.

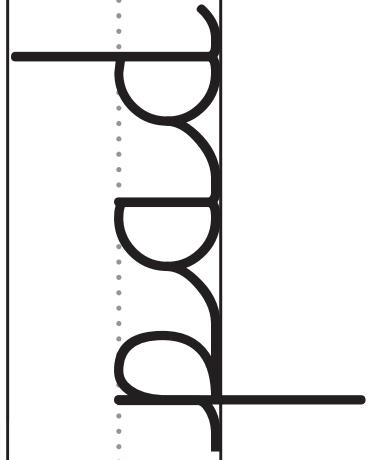



e i s l

Name: \_\_\_\_\_

*e* *i* *s* *l*

teacher check:

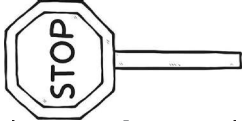

cursive e:

Start on the dot. Copy the models.

*e* *i* *s* *l*

*e* *i* *s* *l*

l i s l

Name: \_\_\_\_\_

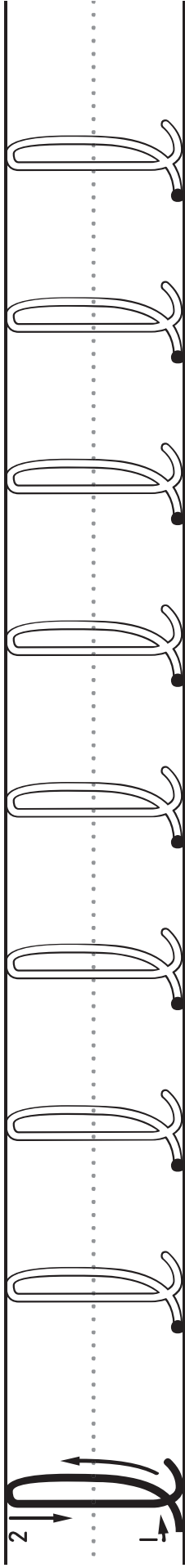

teacher check:

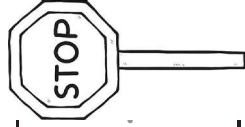

cursive l:

Start on the dot. Copy the models.

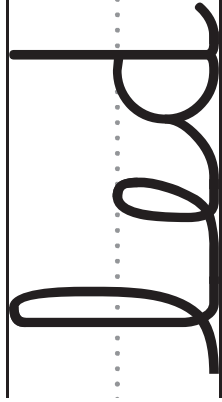
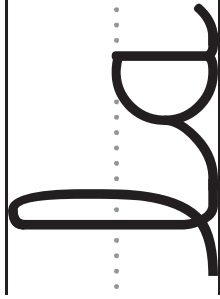

f i s f

Name: \_\_\_\_\_

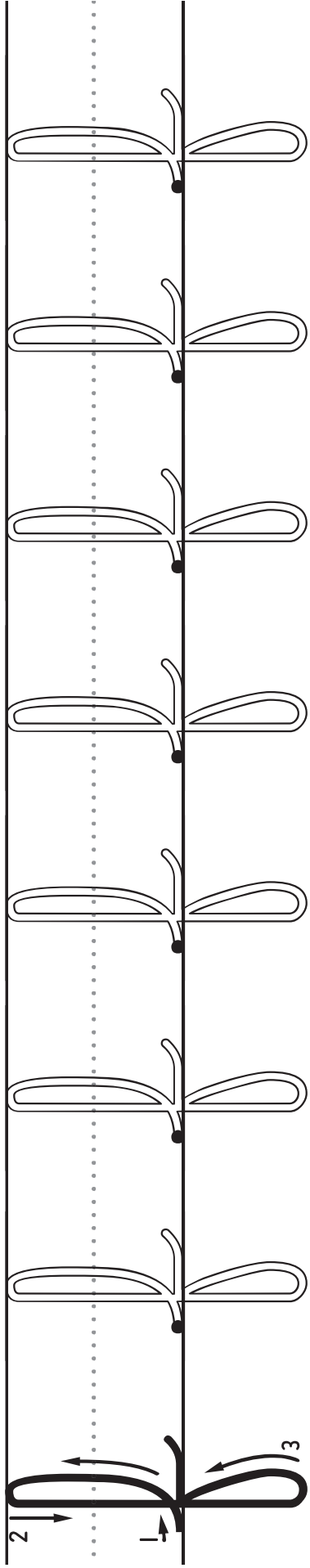

teacher check:

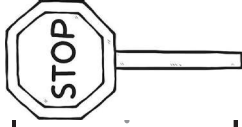

cursive f:

Start on the dot. Copy the model.

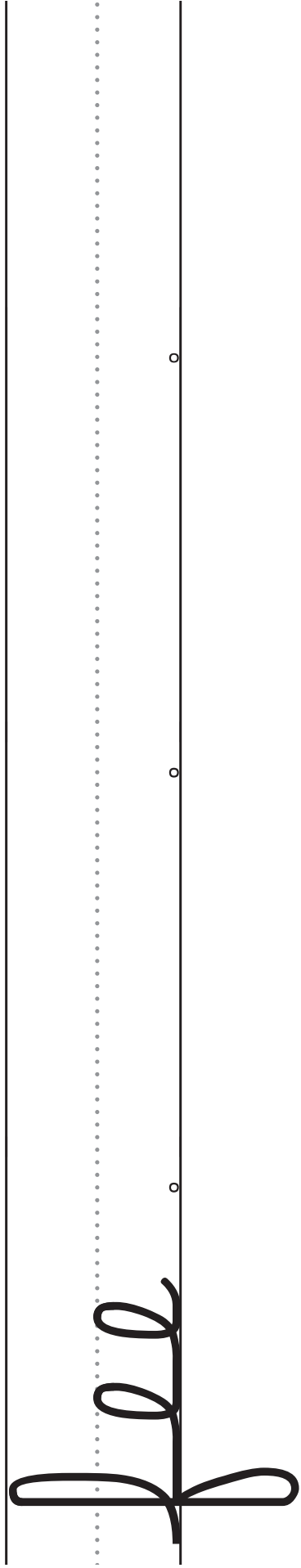

u i s u

Name: \_\_\_\_\_

1 2 u u u u u u u

teacher check:

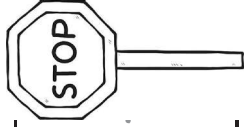

.....

cursive u:

Start on the dot. Copy the models.

u u u

u u u u

y is y

Name: \_\_\_\_\_

1 2 3

teacher check:

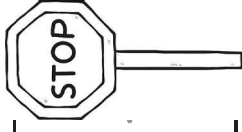

cursive y:

Start on the dot. Copy the model.

y y y y

i i s i

Name: \_\_\_\_\_

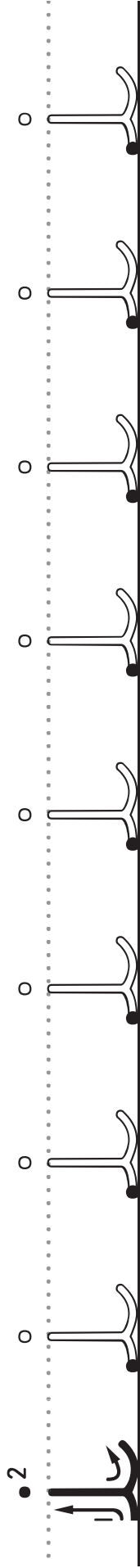

teacher check:

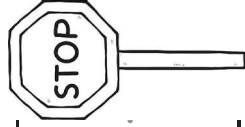

cursive i:

Start on the dot. Copy the models.

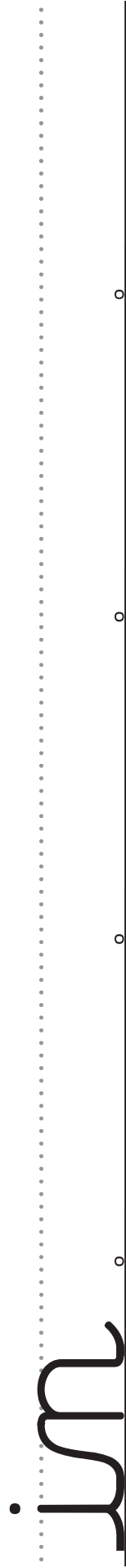
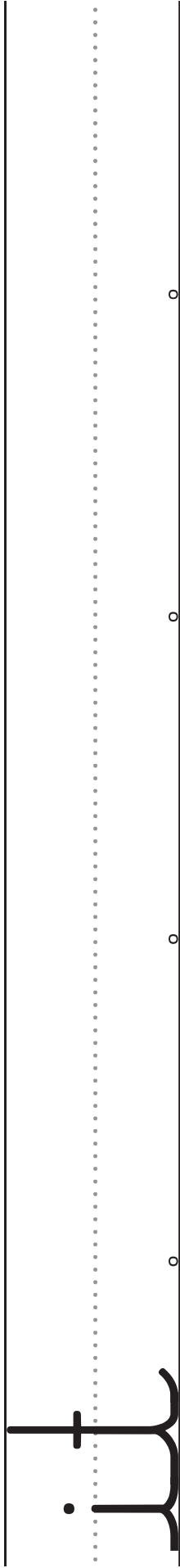

j i s j

Name: \_\_\_\_\_

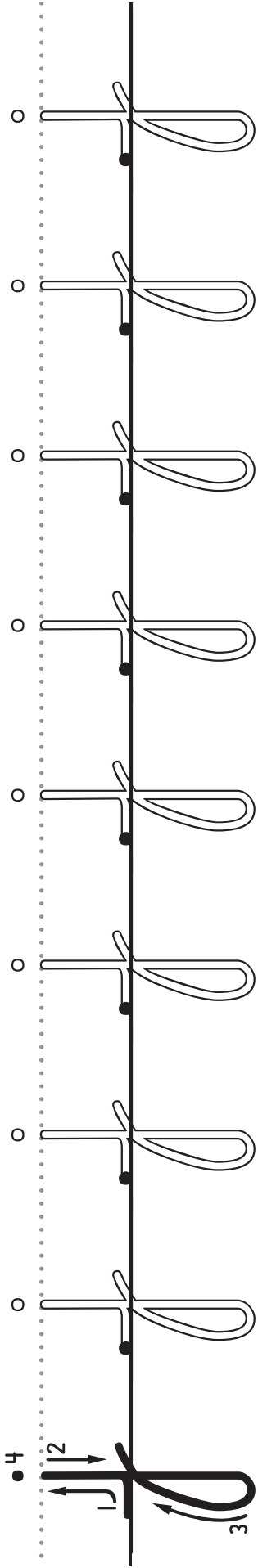

teacher check:

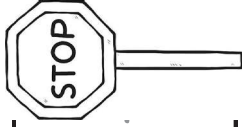

cursive j:

Start on the dot. Copy the model.

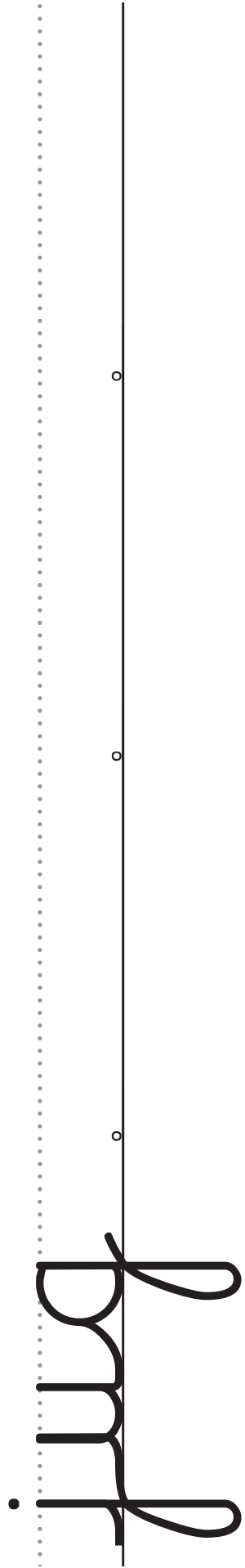

k i s k

Name: \_\_\_\_\_

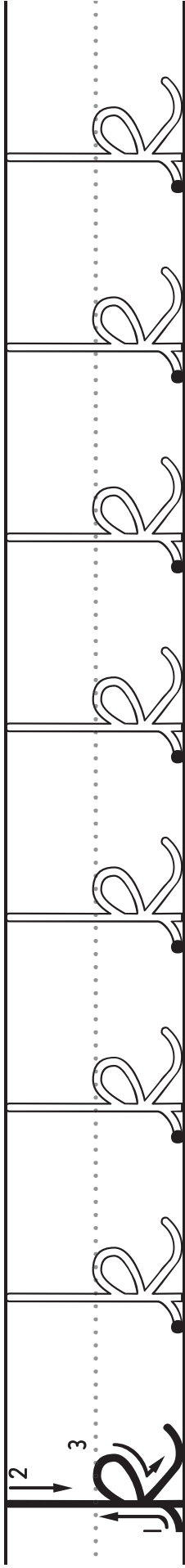

teacher check:

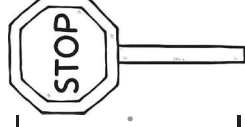

cursive k:

Start on the dot. Copy the models.

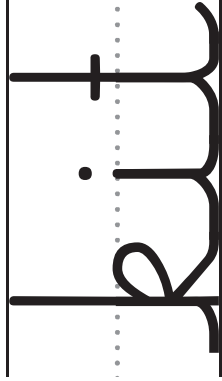
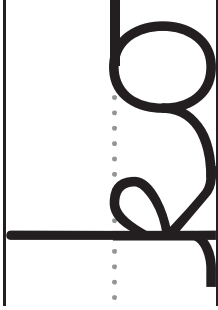



r i s r

Name: \_\_\_\_\_

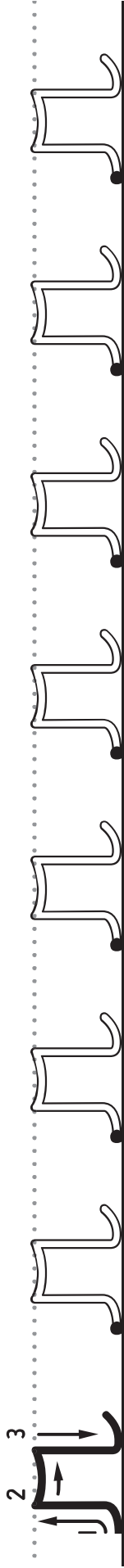

teacher check:

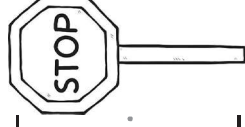

cursive r:

Start on the dot. Copy the models.

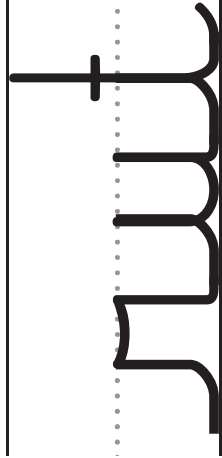

s i s A

Name: \_\_\_\_\_

A A A A A A A A

teacher check:

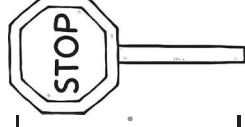

cursive s:

Start on the dot. Copy the models.

A o o

A h e

o i s o

Name: \_\_\_\_\_

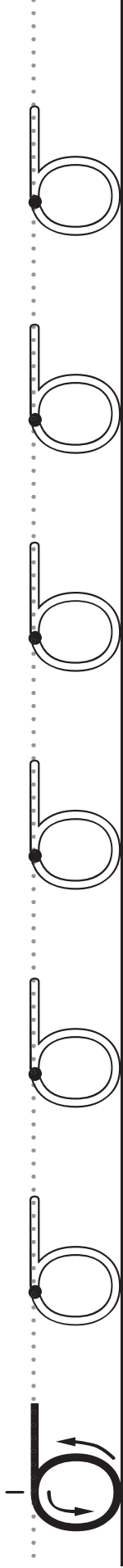

teacher check:

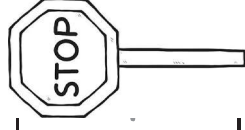

cursive o:

Start on the dot. Copy the models.

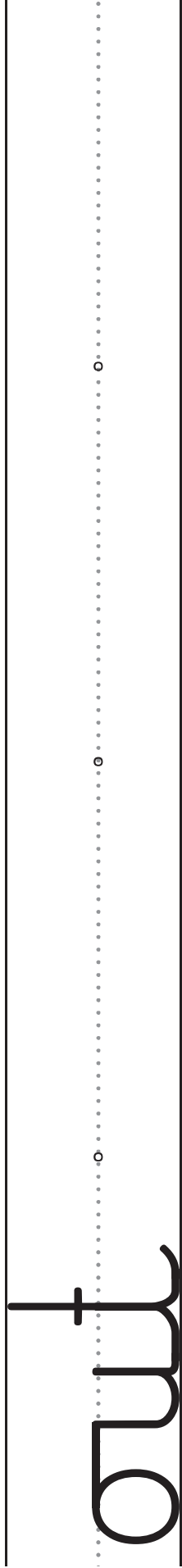

W i s w

Name: \_\_\_\_\_

1 2  
w w w w w w

teacher check:

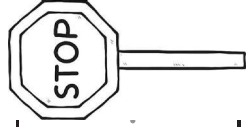

.....

cursive w:

Start on the dot. Copy the models.

.....

w m

.....

w o w

b is b

Name: \_\_\_\_\_

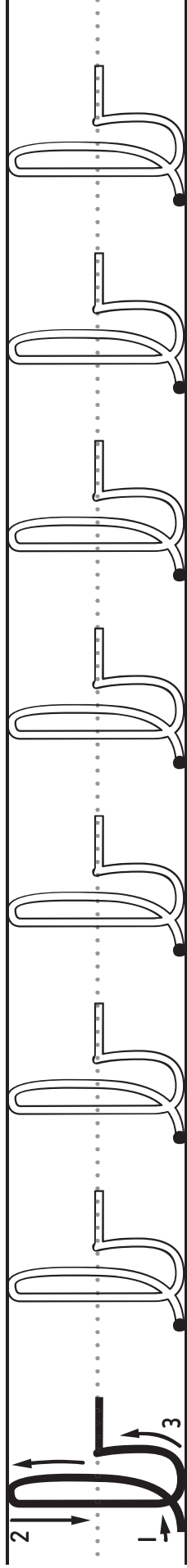

teacher check:

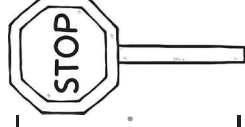

cursive b:

Start on the dot. Copy the models.

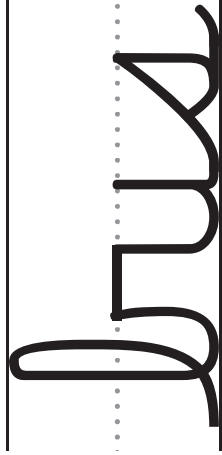
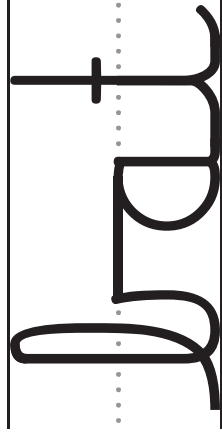

v i s v

Name: \_\_\_\_\_

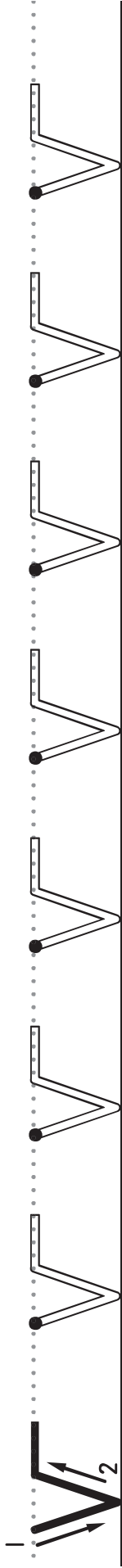

teacher check:

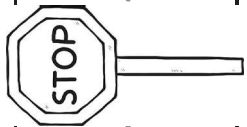

cursive v:

Start on the dot. Copy the models.

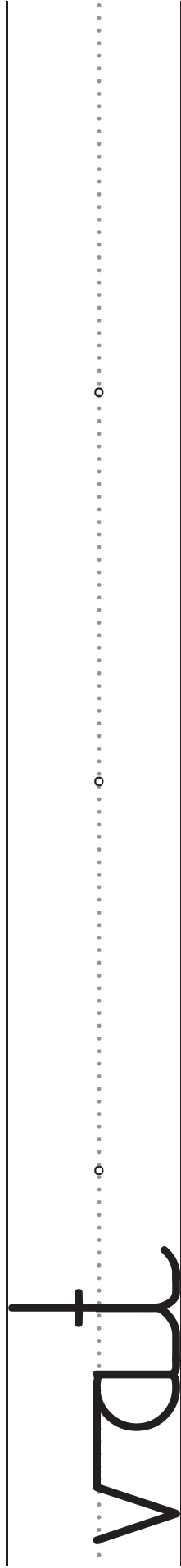

m i s m

Name: \_\_\_\_\_

2 3  
m m m m m

teacher check:

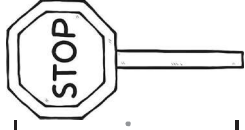

cursive m:

Start on the dot. Copy the models.

m e d

m o m

n i s m

Name: \_\_\_\_\_

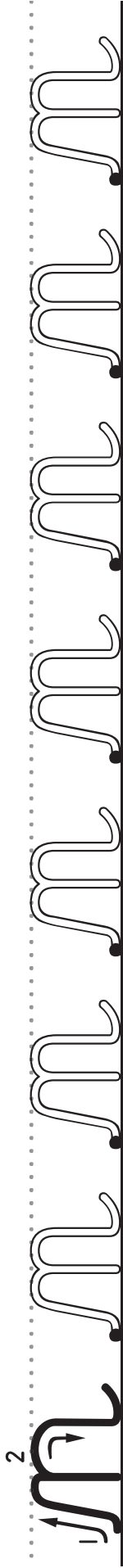

teacher check:

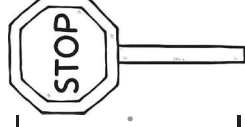

cursive n:

Start on the dot. Copy the models.

m o

m e t



x i s X

Name: \_\_\_\_\_

\_\_\_\_\_

X X X X X X X X X X

teacher check:

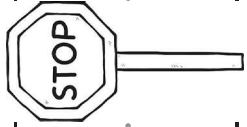

cursive x:

Start on the dot. Copy the models.

X X

\_\_\_\_\_

rut

X X X X X X X X X X

q i s q

Name: \_\_\_\_\_

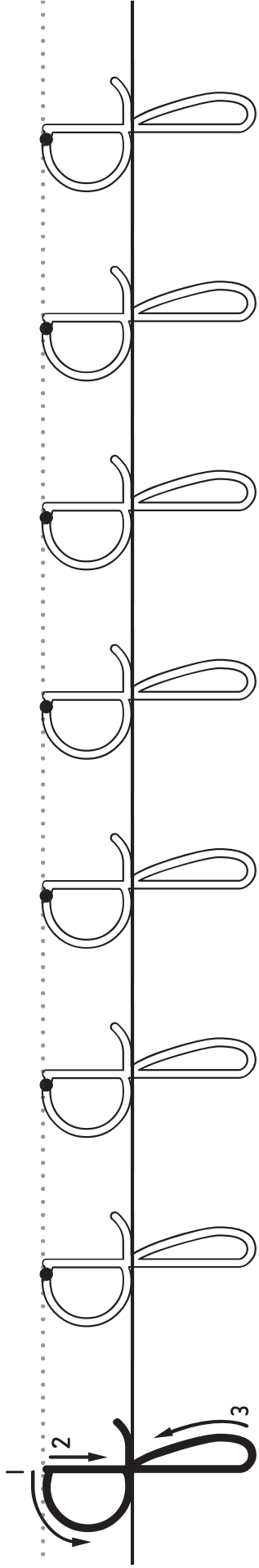

teacher check: \_\_\_\_\_

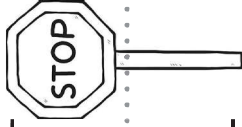

cursive q:

Start on the dot. Copy the model.

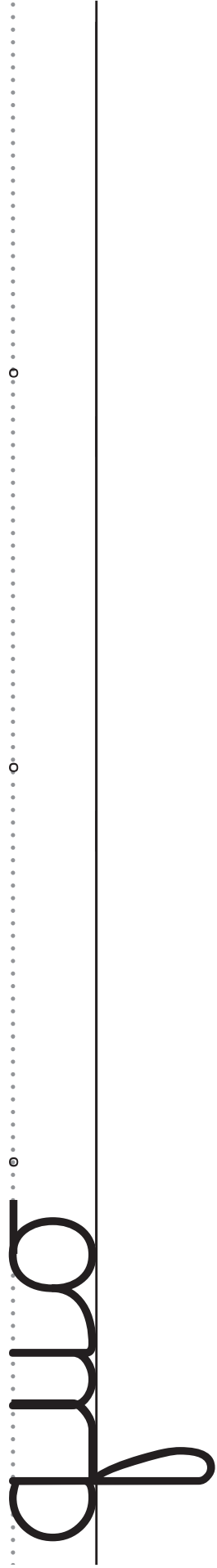

z is z

Name: \_\_\_\_\_

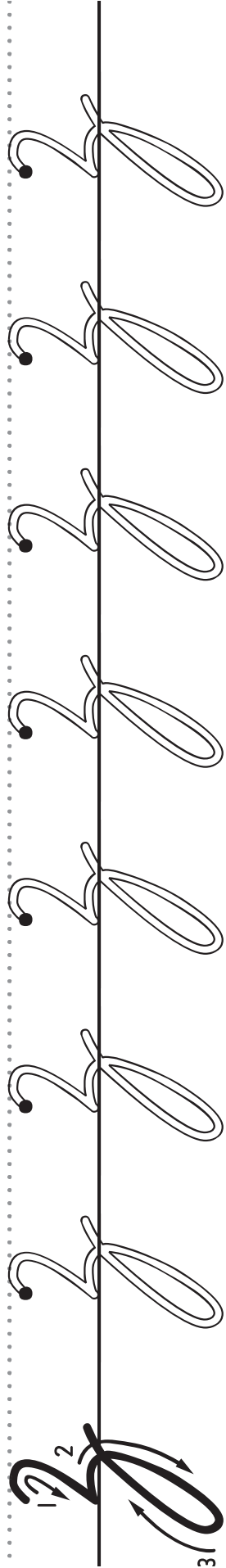

teacher check:

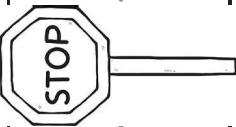

cursive z:

Start on the dot. Copy the model.

